

# IDS-342GT(+)

## Industrial 4-port secure serial to Ethernet device server with 4xRS-232/422/485 and 2x10/100/1000Base-T(X)

### Features

- Operating Modes: Virtual Com, Serial Tunnel, TCP Server, TCP Client, UDP, Modbus Gateway
- Redundant multiple host devices:  
5 host devices: Virtual COM, TCP Server, TCP Client mode;  
4 IP ranges: UDP
- Support Modbus Gateway : Modbus TCP, Modbus RTU, Modbus ASCII
- Support 2 Gigabit Ethernet ports for high speed data transmission
- Security: SSL data encryption; secured management by HTTPS and SSH
- 1KV isolation for PoE P.D. port
- Supports 9.6K Bytes Jumbo Frame
- Event Warning by Syslog, SNMP trap, Relay and Beeper
- Configurable by Web-based and Windows utility (**DS-Tool**)
- Various Windows O.S. supported:  
Windows NT/2000/ XP/ 2003/VISTA(32/64bit)/ Windows 7(32/64bit)



### Introduction

IDS-342GT(+) is an innovative secure 4 port RS-232/422/485 to 2 ports Gigabit Ethernet secure device server with standard features of device server, such like TCP/IP interface and versatile operation modes: Virtual Com, Serial Tunnel, TCP Server, TCP Client, and UDP. In addition, the Windows utility, DS-Tool, could configure multiple devices and set up the mappings of Virtual Com. On the other hand, IDS-342GT(+) can simultaneously transfer data up to 5 redundant host PCs to avoid Ethernet connection breakdown or any host PC fails. Further, IDS-342GT(+) features HTTPS, SSH, and SSL encryption to assure the security of critical data transmission.

IDS-342GT(+) supports RS-232/422/485 and provides dual redundant power inputs, 12~48 VDC, on terminal block to guarantee a non-stop operation. In addition, IDS-342GT+ also provides P.D. feature at ETH2 port which is fully compliant with IEEE802.3af PoE P.D. specification to save the layout cost of power line. With wide operating temperature, -40~70°C,

and rugged IP-30 housing design, IDS-342GT(+) series could operate in the harsh industrial environment. Therefore, IDS-342GT(+) is the best solution to the high demand of secure serial to Ethernet critical data communication.

## Practical Operation

In practical operation of serial device servers, Windows utility (DS-Tool) is supported. This utility is very helpful for you to manage and monitor all of industrial device servers on the industrial network.

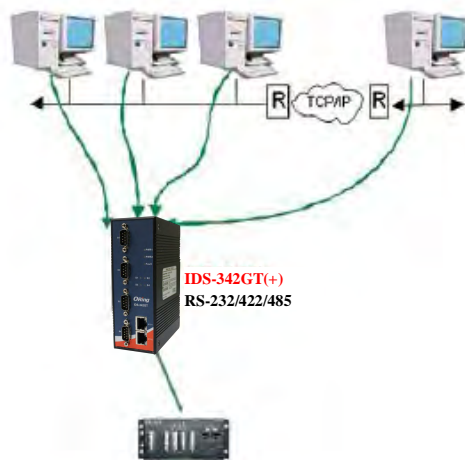

**Multiple Host PCs**

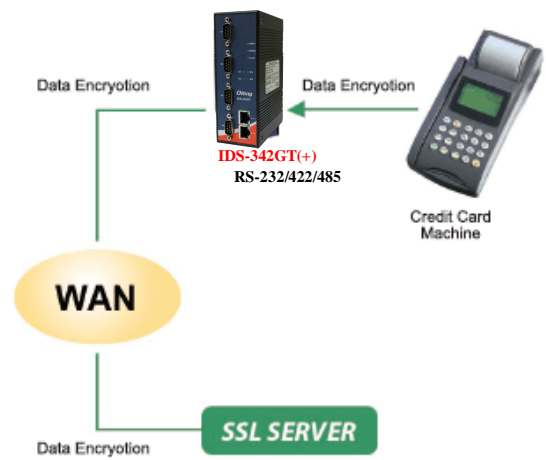

**SSL Data Encryption**

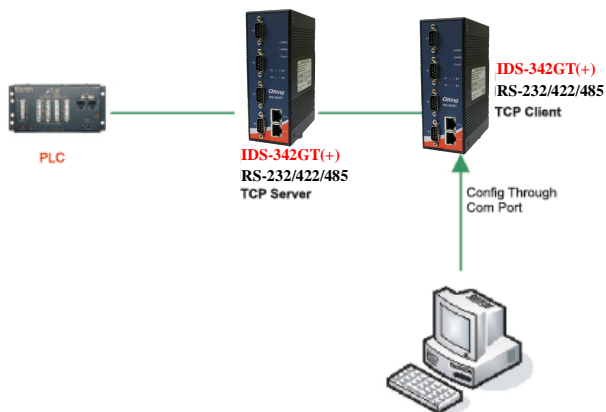

## TCP Client/Server Modes

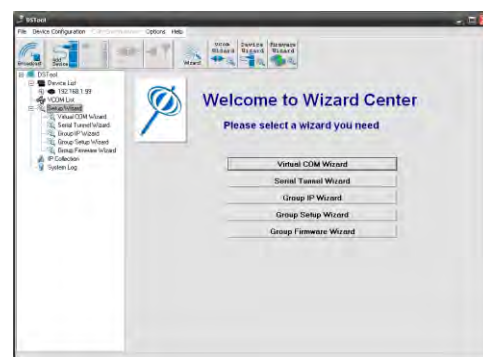
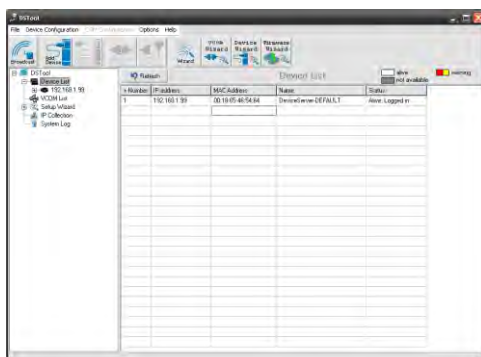

**DS-Tool (Windows Utility): Monitoring and Configuration**

## Pin Definition

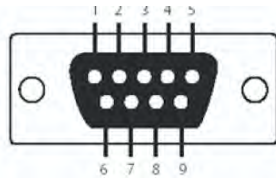

DB9 connector

Pin #	RS-232	RS-422	RS-485 ( 4 wire )	RS-485 ( 2 wire )
1	DCD	TX-	TX-	DATA -
2	RXD	TX+	TX+	DATA +
3	TXD	RX+	RX+	
4	DTR	RX-	RX-	
5	GND	GND	GND	
6	DSR			
7	RTS			
8	CTS			
9	RI			

## Dimension

### Dimension

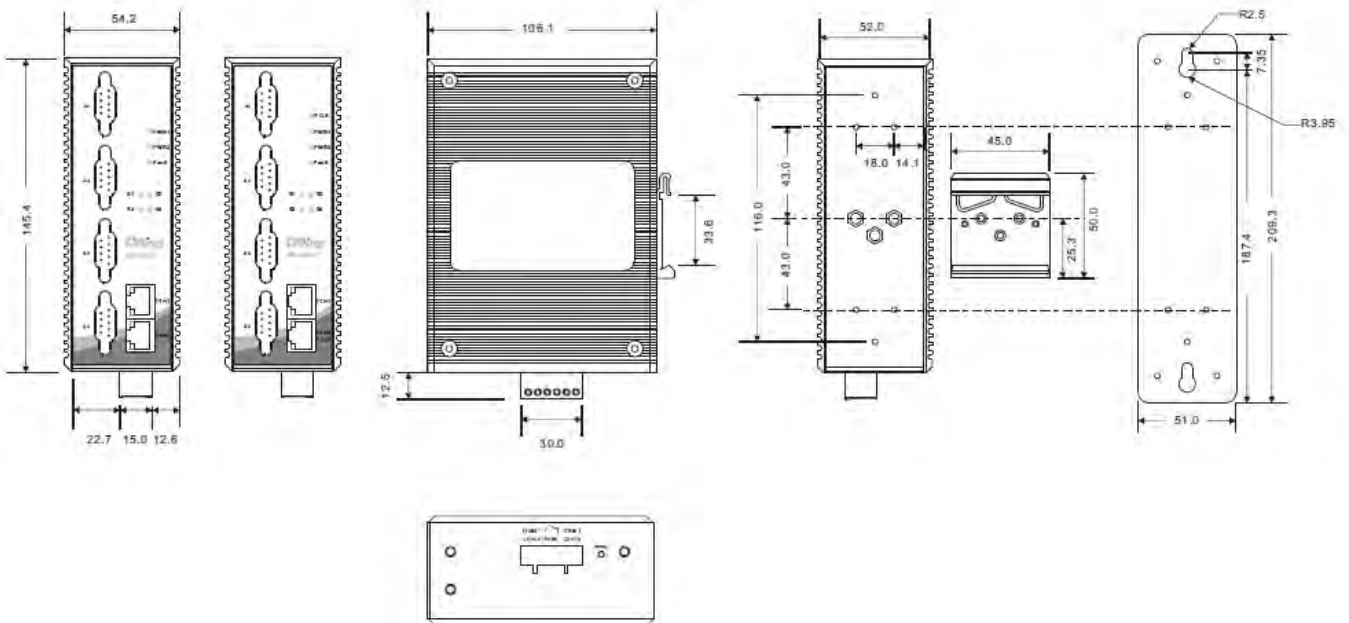

# Specifications

ORing Device Server Model	IDS-342GT	IDS-342GT+
<b>Physical Ports</b>		
10/100/1000 Base-T(X) Ports in RJ45 Auto MDI/MDIX	<b>2</b>	
PoE P.D. port		Present at ETH2 Fully compliant with IEEE 802.3af Power Device specification Over load & short circuit protection Isolation Voltage: 1000 VDC min. Isolation Resistance : 10 <sup>8</sup> ohms min
<b>Serial Ports</b>		
Connector	DB9 x 4	
Operation Mode	RS-232/422/485	
Serial Baud Rate	110 bps to 921.6 Kbps	
Data Bits	7, 8	
Parity	odd, even, none, mark, space	
Stop Bits	1, 1.5, 2	
RS-232	TxD, RxD, RTS, CTS, DTR, DSR, DCD, RI, GND	
Flow Control	XON/XOFF, RTS/CTS, DTR/DSR	
<b>Network Protocol</b>		
Protocol	ICMP, IP, TCP, UDP, DHCP, BOOTP, SSH, DNS, SNMP V1/V2c, HTTPS	
Jumbo frame	Up to 9.6K Bytes	
<b>LED indicators</b>		
Power indicator	PWR 1(2) / Ready: Green On: Power is on and functioning Normally.	
10/100/1000 RJ45 port indicator	Top Green for port Link at 1000Mbps, Amber for port Link at 100Mbps, off for port Link at 10Mbps Bottom Green for port Link/Act	
Serial TX / RX LEDs:	Red: Serial port is receiving data Green: Serial port is transmitting data	
<b>Power</b>		
Redundant Input power	Dual DC inputs. 12-48VDC on 6-pin terminal block	
Power consumption (Typ.)	6.96W	
Overload current protection	Present	
Reverse polarity protection	Present on terminal block	
<b>Physical Characteristic</b>		
Enclosure	IP-30	
Dimension (W x D x H)	54.2(W)x106.1(D)x145.4(H) mm (2.13x4.18x5.72 inch.)	
Weight (g)	740g	745g
<b>Environmental</b>		
Storage Temperature	-40 to 85°C (-40 to 185°F)	
Operating Temperature	-40 to 70°C (-40 to 158°F)	
Operating Humidity	5% to 95% Non-condensing	
<b>Regulatory approvals</b>		
EMI	FCC Part 15, CISPR (EN55022) class A	
EMS	EN61000-4-2 (ESD), EN61000-4-3 (RS), EN61000-4-4 (EFT), EN61000-4-5 (Surge), EN61000-4-6 (CS), EN61000-4-8, EN61000-4-11	
Shock	IEC60068-2-27	
Free Fall	IEC60068-2-32	
Vibration	IEC60068-2-6	

Safety	EN60950-1
<b>Warranty</b>	5 years

## Ordering Information

**IDS-3ABCCD**

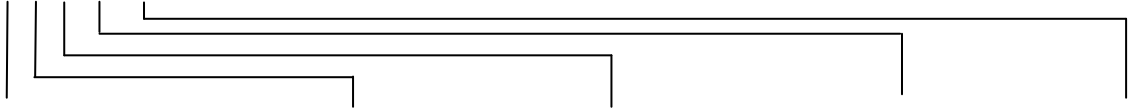

Code Definition	Serial Port Type	Serial Port Number	Ethernet port Number	Ethernet port Type	PoE Identification
Option	- 1: RS-232 - 2: RS-422/485 - 3: RS-232/422/485	- 4: 4 ports	- 2: 2 ports	- GT: Gigabit Ethernet	- +: PoE P.D. present

Available Model	Model Name	Description
	IDS-342GT	Industrial 4-port secure serial to Ethernet device server with 4xRS-232/422/485 and 2x10/100/1000Base-T(X)
	IDS-342GT+	Industrial 4-port secure serial to Ethernet device server with 4xRS-232/422/485 and 2x10/100/1000Base-T(X) with 1-port PoE P.D.

## Packing List

- **IDS-342GT(+)** x 1
- **CD** x 1
- **Quick Installation Guide** x 1

## Optional Accessories

- **DR-45 series** : 45 Watts power supply
- **DR-75 series** : 75 Watts power supply
- **DR-120 series** : 120 Watts power supply