

# Digi XBee XR 900

The Digi XBee XR family operates in the 902 to 928 MHz range, delivering superior performance and interference immunity at 900 MHz

The **Digi XBee® XR 900** module is a compact and reliable solution supporting deployment of long-range connectivity applications. The pre-certified module operates between 902 and 928 MHz in compliance with standards.

### Secure, robust and reliable

The Digi XBee XR 900 modules can be configured easily using Digi's easy-to-use **Digi XBee Studio** software or via Digi's simplified AT or API command sets. They are pre-certified for use in multiple countries and include integrated antennas, removing the burden of RF development and support costs, and enabling fast time to market for OEM designs.

The utilization of Frequency Hopping Spread Spectrum (FHSS) on the XBee XR along with an industrial temperature range of -40 °C to 85 °C (-40 °F to 185 °F) make it ideal for applications in noisy, challenging environments.

The module supports both point-to-point and mesh networking protocols (**DigiMesh®**) with a line-of-sight range up to 17 kilometers. It is well suited for agriculture and energy applications where long-distance communication is required.

The Digi XBee XR 900 RF module is a complete hardware and software solution that works directly out of the box. Development kits and **Digi XBee Tools** support the complete IoT application lifecycle, from evaluation, testing and prototyping through manufacturing and deployment to long-term network management.

### Key features, benefits and applications

- Fully certified for use in unlicensed 900 MHz band
- RF module based on Silicon Labs EFR32 microcontroller
- Design includes SAW filter for optimal performance in noisy RF environments
- 256-bit AES encryption for secure data communication
- **DigiMesh** networking topology for redundancy and reliability
- Simple and advanced configuration using **Digi XBee Studio** accelerates time to market
- **Digi XBee Tools** to simplify tasks and get to market faster

### Application example

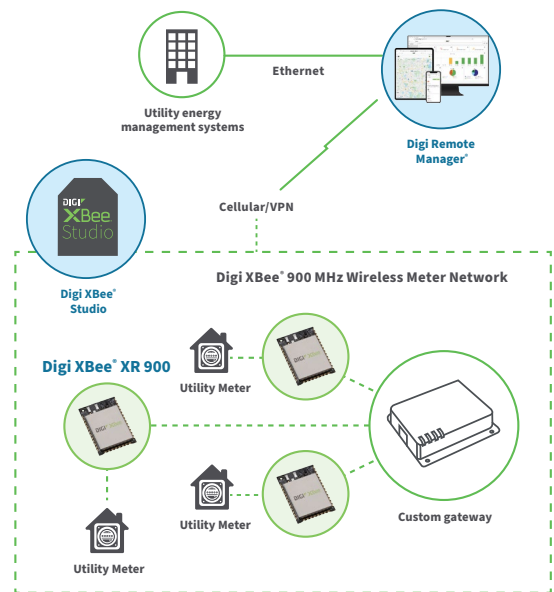

Need custom gateway engineering support?  
**Contact Digi Wireless Design Services.**

### Related Digi devices





Manage and configure Digi XBee XR 900 modules with Digi XBee Studio

Specifications	Digi XBee XR 900
<b>HARDWARE</b>	
PROCESSOR	EFR32FG13P231F512 transceiver at 40 MHz
FREQUENCY BAND	902 MHz – 928 MHz; Australia / New Zealand: 915 MHz – 928 MHz
AVAILABLE FORM FACTORS	Micro-mount (MMT), surface-mount (SMT), through-hole (TH)
ANTENNA OPTIONS	MMT: U.FL connector, RF pad; SMT: U.FL connector, RF pad, chip antenna; TH: SMA, U.FL connector
WEIGHT	MMT: 1.2 g (0.042 oz) SMT: 3.0 g (0.106 oz) TH: 3.1 g (0.109 oz)
DIMENSIONS	MMT: 13 mm x 19 mm x 2 mm (0.533 in x 0.76 in x 0.087 in) SMT: 2.199 cm x 3.4 cm x 0.305 cm (0.866 in x 1.33 x 0.120 in) TH: 2.438 cm x 2.761 cm (0.960 in x 1.087 in)
<b>PERFORMANCE</b>	
RF DATA RATE	Low data rate: 10 kbps, middle data rate: 110 kbps, high data rate: 250 kbps
UART DATA RATE	Up to 921.6 kbps
SPI DATA RATE	Up to 5 Mbps
LINE-OF-SIGHT RANGE*	Up to 17 km (10.5 mi) rural, up to 3 km (1.8 mi) urban
INDOOR RANGE	Up to 140 m (460 ft)
TRANSMIT POWER	Up to 19 dBm ERP; New Zealand: up to 13 dBm
RECEIVER SENSITIVITY	Low data rate: –113 dBm, middle data rate: –108 dBm, high data rate: –104 dBm
RECEIVER BLOCKING	Below 900 MHz and above 930 MHz; >70 dB
<b>FEATURES</b>	
DIGITAL I/O	15
AVAILABLE CHANNEL FREQUENCIES	Low and middle data rate: 101**, high data rate: 50 Australia: 49 (low/middle), 24 (high); New Zealand: 41 (low/middle), 11 (high)
ANALOG INPUTS	(4) 10-bit ADC inputs
OPERATING TEMPERATURE	–40 °C to 85 °C (–40 °F to 185 °F)
NETWORKING TOPOLOGIES	Point-to-point/point-to-multipoint, DigiMesh; SX protocol compatible
SECURITY	256-bit AES encryption
<b>POWER</b>	
SUPPLY VOLTAGE	2.1 – 3.6 VDC, 3.3 VDC typical
TRANSMIT CURRENT	110 mA
RECEIVE CURRENT	28 mA
SLEEP CURRENT	1.2 uA
<b>REGULATORY APPROVALS**</b>	
FCC (USA)	Yes
ISED (CANADA)	Yes
ROHS	Yes
AUSTRALIA / NEW ZEALAND	Yes

\*Range figure estimates are based on free-air terrain with limited sources of interference. Actual range will vary based on transmitting power, orientation of transmitter and receiver, height of transmitting antenna, height of receiving antenna, weather conditions, interference sources in the area, and terrain between receiver and transmitter, including indoor and outdoor structures such as walls, trees, buildings, hills, and mountains.

\*\*Visit [digi.com/resources/certifications](http://digi.com/resources/certifications) for latest updates.

## DIGI XBEE XR 900

# Management and Configuration

## Digi XBee Studio

Free multi-platform application that enables developers to manage Digi XBee devices through a simple-to-use graphical interface

**Digi XBee Studio** is the definitive tool to manage and configure Digi XBee devices. This next generation configuration tool suite supersedes **Digi XCTU** and offers an advanced set of tools that make it easy to set up, configure, communicate with and test Digi XBee modules and devices.

The first thing you need to do in order to work with XBee devices in XBee Studio is to add them to the tool. In XBee Studio, this is easier than ever.

### Simple setup and connectivity

Just after startup, XBee Studio will automatically look for XBee devices connected to your computer. As modules are found, they will appear in the Device Browser view. The Device Browser view displays all the devices connected to your computer.

### View and manage your Digi XBee devices

View all of your Digi XBee devices in one table, or if they are geo-located, you can switch to the map view and see the location of each one.

Digi XBee Studio also offers a simple and step-by-step way to access and manage devices, including additional options for configuration, diagnostics, development, remote management and other utilities.

### Proven experience and expert support

Our decades of embedded experience and millions of deployed devices tell our story; Digi is a trusted solutions provider dedicated to simplifying the way OEMs design, build, deploy and maintain secure connected products.

**Digi Wireless Design Services (WDS)** is an engineering team that provides additional connectivity integration support, certification assistance, and custom design and build services to get your products to market smarter and faster. The expert team of WDS engineers can support you wherever you are along your development path.



### Key features

- **Deploy on multiple platforms:** Digi XBee Studio is compatible with the most popular operating systems, including Microsoft Windows, macOS and Linux.
- **Discover your devices:** Automatically discover XBee devices connected to your computer, regardless of their port connections or configured settings.
- **Configure any device:** Manage and configure multiple XBee devices at once, including devices enrolled in your Digi Remote Manager account located anywhere in the world.
- **Communicate with your devices:** Use the new smart XBee console to communicate with your devices regardless of whether they are configured for API mode or transparent mode..
- **Access a range of tools:** Use embedded tools to perform operations like creating XBee profiles or recovering your devices.
- **Get automatic updates:** Automatically update the application itself, as well as the radio firmware library, without downloading any extra files.

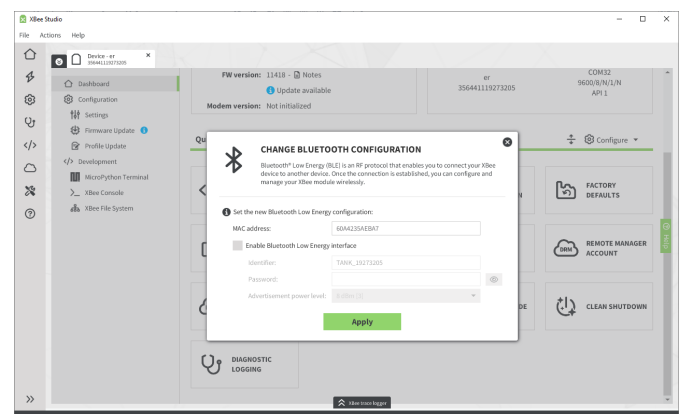

## DIGI XBEE XR 900

# Digi XBee Ecosystem, Tools and Supporting Services

## Digi XBee Ecosystem

The world-renowned XBee module is part of a family of cellular modems and RF modules that provide ultimate flexibility for IoT application developers, with three programmable form factors, and a range of popular wireless protocols. The XBee family also includes IoT gateways and management tools to connect, monitor and manage your XBee network. [Learn more at digi.com/xbee](http://digi.com/xbee).

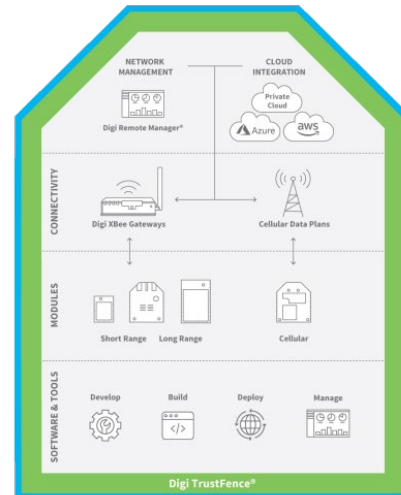

## Digi XBee Tools

The **Digi XBee Ecosystem** is fully supported with the award-winning **Digi XBee Tools** suite. Designed to support the full product lifecycle, from prototyping and development to deployment and ongoing monitoring, Digi XBee Tools includes code libraries, testing and prototyping tools, product development and manufacturing support, and tools for deploying and managing end devices in the field.



DEVELOP



BUILD



DEPLOY



MANAGE

## Digi Wireless Design Services



DEFINITION



DEVELOPMENT



CERTIFICATION



MANUFACTURING

## Digi WDS Services

We offer services to support you wherever you are along your development path, with a record that speaks for itself.

- Proof of concept
- Architecture consultation
- Requirements definition
- System, software and electrical design
- Design reviews
- Certifications
- Prototype build
- Manufacturing test fixtures
- 250+ product development projects
- 100+ certification failure rescues
- 100 million connected devices around the globe

## Get to market faster with Digi WDS

**Digi Wireless Design Services** (WDS) has a proven history of helping clients speed down the path to success by guiding them through the technological and regulatory certification pitfalls that botch budgets and disrupt product introductions.

We begin by actively listening to your business and technical requirements, and then leverage our proven methodology, world-class engineering expertise and library of IP to design a cost-effective solution that is tailored to your specific needs. Accelerate toward the solution that is right for you and your customers.

Contact **Digi WDS** to find out how we can guide you to success.

# DIGI XBEE XR 900

## Photos

### Digi XBee XR 900 photos and dimensions



19 mm



13 mm

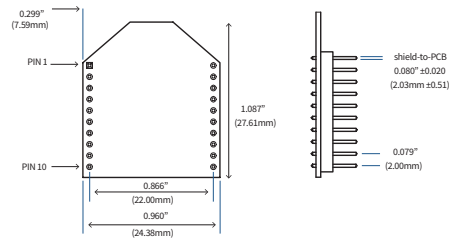
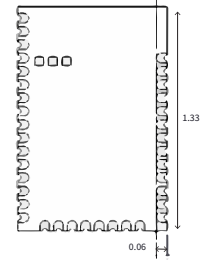
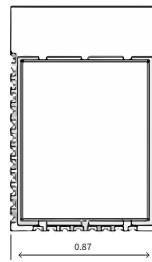
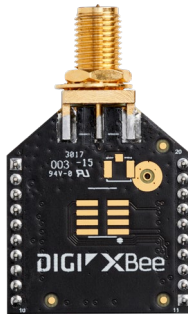
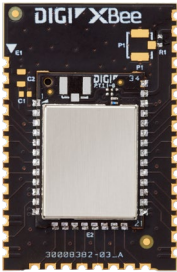
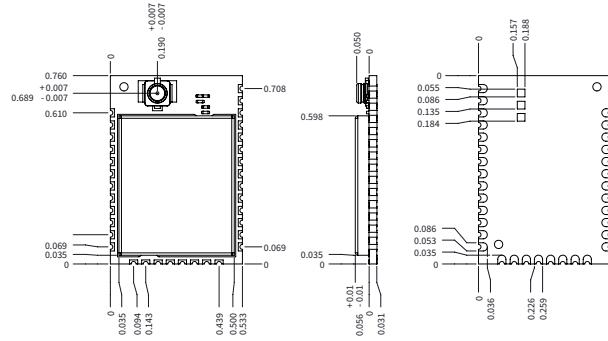
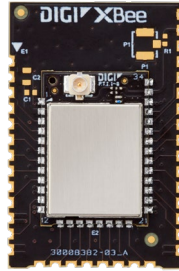

## DIGI XBEE XR 900

# Part Numbers

Part Numbers	Digi XBee XR 900
DIGI XBEE XR 900 MICRO-MOUNT (MMT)	
XB-9XR-DMRM-001	Digi XBee XR 900 MHz, DigiMesh, RF pad, MMT
XB-9XR-DMUM-001	Digi XBee XR 900 MHz, DigiMesh, U.FL, MMT
DIGI XBEE XR 900 SURFACE-MOUNT (SMT)	
XB-9XR-DMCS-001	Digi XBee XR 900 MHz, DigiMesh, chip, SMT
XB-9XR-DMRS-001	Digi XBee XR 900 MHz, DigiMesh, RF pad, SMT
XB-9XR-DMUS-001	Digi XBee XR 900 MHz, DigiMesh, U.FL, SMT
DIGI XBEE XR 900 THROUGH-HOLE (TH)	
XB-9XR-DMST-001	Digi XBee XR 900 MHz, DigiMesh, SMA, TH
XB-9XR-DMUT-001	Digi XBee XR 900 MHz, DigiMesh, U.FL, TH

Part Numbers	Digi XBee XR 900 — Australia and New Zealand
DIGI XBEE XR 900 MICRO-MOUNT (MMT) — AUSTRALIA	
XB-9XR-DMRM-021	Digi XBee XR 900 MHz, DigiMesh, RF pad, MMT — Australia
XB-9XR-DMUM-021	Digi XBee XR 900 MHz, DigiMesh, U.FL, MMT — Australia
DIGI XBEE XR 900 SURFACE-MOUNT (SMT) — AUSTRALIA	
XB-9XR-DMRS-021	Digi XBee XR 900 MHz, DigiMesh, RF pad, SMT— Australia
XB-9XR-DMUS-021	Digi XBee XR 900 MHz, DigiMesh, U.FL, SMT — Australia
DIGI XBEE XR 900 MICRO-MOUNT (MMT) — NEW ZEALAND	
XB-9XR-DMRM-031	Digi XBee XR 900 MHz, DigiMesh, RF pad, MMT — New Zealand
XB-9XR-DMUM-031	Digi XBee XR 900 MHz, DigiMesh, U.FL, MMT — New Zealand
DIGI XBEE XR 900 SURFACE-MOUNT (SMT) — NEW ZEALAND	
XB-9XR-DMRS-031	Digi XBee XR 900 MHz, DigiMesh, RF pad, SMT — New Zealand
XB-9XR-DMUS-031	Digi XBee XR 900 MHz, DigiMesh, U.FL, SMT — New Zealand

Part Numbers	Digi XBee XR 900 Development Kit
DIGI XBEE XR 900 DEVELOPMENT KIT	
XK-9XR-DMM-0	Digi XBee XR 900 Development Kit with Digi XBee XR 900 MHz, U.FL, MMT

For more information, visit [digi.com](https://digi.com).



For more information about Digi XBee XR 900, visit [digi.com/xr900](https://digi.com/xr900).

877-912-3444 | 952-912-3444

